

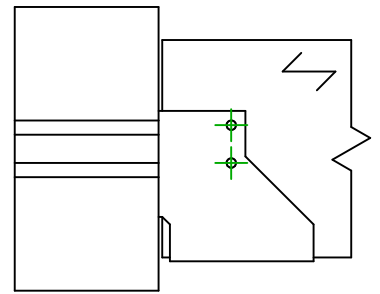

Référence =	BSIN200	
Fixations =	Bois sur bois	Solive sur poutre
Type de fixation =	Clouage total	

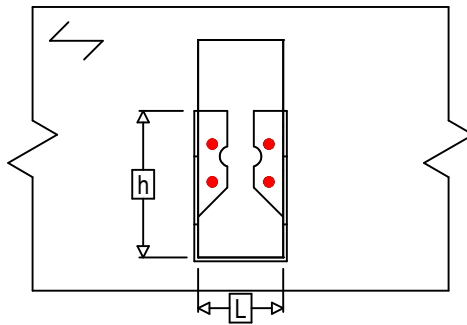

$$h = (200 - L) / 2$$

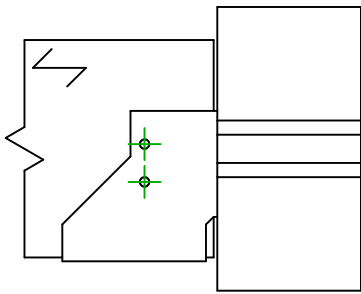
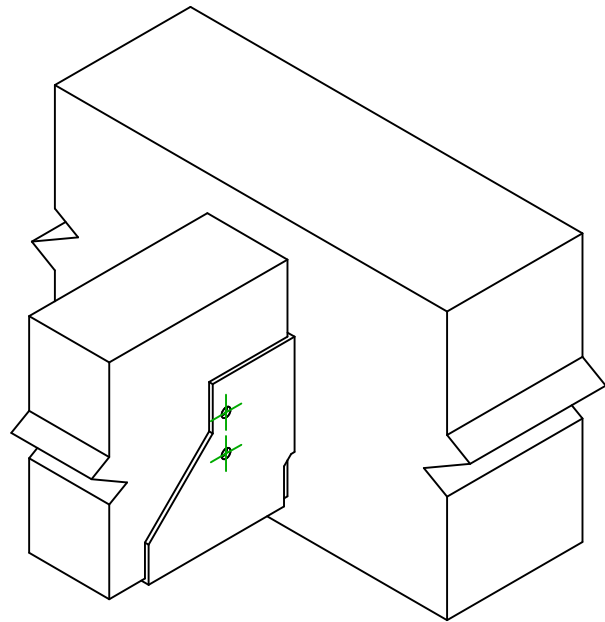

Fixation(s)	Symbole	Fixations	Fixations		Qté	
	Porteur		CNA	CNA4.0X35 / CNA4.0X50		4
CSA			CSA5.0X35 / CSA5.0X40			
-			-			
Fixation(s)	Symbole	Fixations	L < 64mm	L > 64mm	Qté	
		CNA	CNA4.0X35	CNA4.0X50		4
		CSA	CSA5.0X35	CSA5.0X40		