

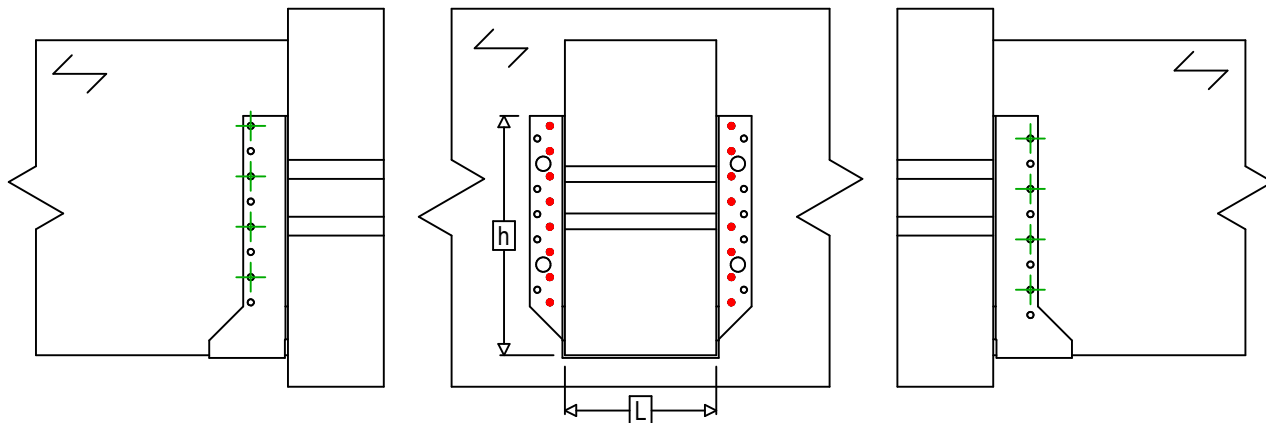

Art. Nr.	=	BSNN500	
Festemidler	=	Tre til Tre	Bjelke til bjelke
Type festemiddel	=	Delvis utspikring	

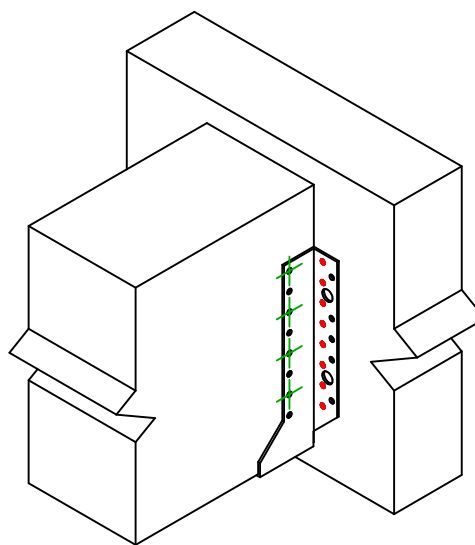

$$h = (500 - L) / 2$$



Festemidler i hovedbjelke	Symbol	Festemidler	Festemidler		Antall	
		CNA		CNA4.0X35 / CNA4.0X50		16
		CSA		CSA5.0X35 / CSA5.0X40		
-		-	-			
Festemidler i sekundærbjelke	Symbol	Festemidler	L < 64mm	L > 64mm	Antall	
		CNA		CNA4.0X35	CNA4.0X50	8
		CSA		CSA5.0X35	CSA5.0X40	