

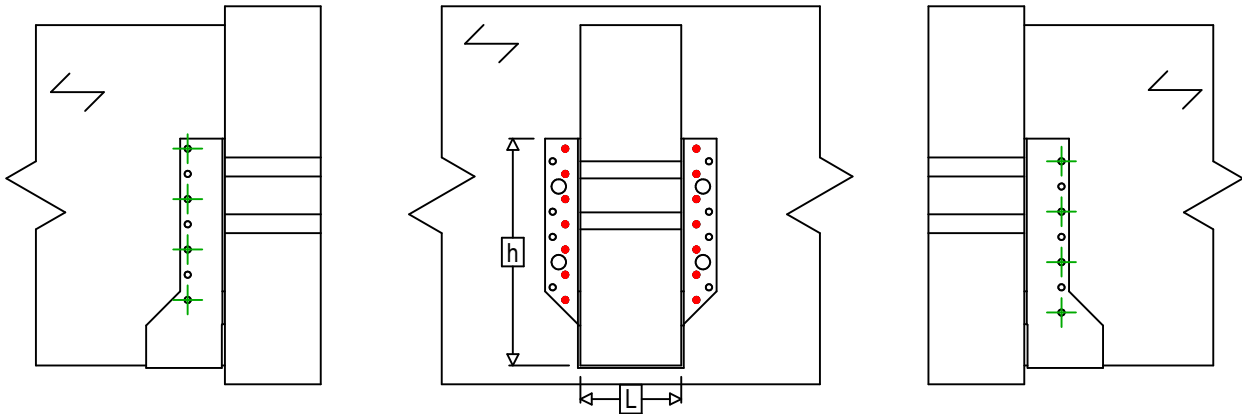

Item	=	BSNN440	
Fasteners	=	Timber to timber	Joist to beam
Type of fastening	=	Partial nailing	

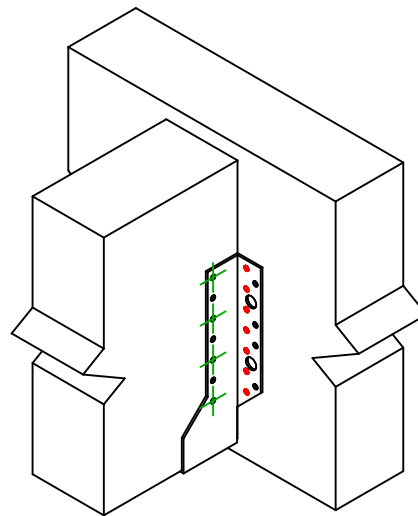

$$h = (440 - L) / 2$$



Header Fastener(s)	Symbol	Fasteners	Fasteners		Qty	
		CNA		CNA4.0X35 / CNA4.0X50		14
		CSA		CSA5.0X35 / CSA5.0X40		
-		-	-			
Joist Fastener(s)	Symbol	Fasteners	L < 64mm	L > 64mm	Qty	
		CNA		CNA4.0X35	CNA4.0X50	8
		CSA		CSA5.0X35	CSA5.0X40	